



Ultra low drop and low noise voltage regulators

Description

The MEQ6310 provides up to 150 mA, from 2.6 V to 6V input voltage. The ultra low drop voltage, low quiescent current and low noise make it suitable for low power applications and in battery-powered systems. Regulator ground current increases slightly in dropout only, prolonging the battery life. Power supply rejection is better than 60 dB at low frequencies and rolls off at 10 kHz. High power supply rejection is maintained down to low input voltage levels common to battery operated circuits. Shutdown logic control function is available, this means that when the device is used as local regulator, it is possible to put a part of the board in standby, decreasing the total power consumption. The MEQ6310 is designed to work with low ESR ceramic capacitors. Typical applications are in mobile phones and similar battery-powered wireless systems.

Applications

- mobile phones
- similar battery-powered wireless systems
- Automotive ECU controller

Feature

- Input voltage from 2.6 V to 6 V
- Stable with low ESR ceramic capacitors
- Ultra low-dropout voltage (60 mV typ. at 150 mA load, 0.4 mV typ. at 1 mA load)
- Very low quiescent current (85 μ A typ. at no load, 170 μ A typ. at 150 mA load; max.1.5 μ A in OFF mode)
- Guaranteed output current up to 150 mA
- Wide range of output voltages: 1.8V、3.0V、3.3V
- Fast turn-on time: typ. 200 μ s ($C_O = 1 \mu$ F, $C_{BYP} = 10$ nF and $I_O = 1$ mA)
- Logic-controlled electronic shutdown
- Internal current and thermal limit
- Output low noise voltage 30 μ V_{RMS} over 10 Hz to 100 kHz
- PSRR of 60 dB at 1 kHz, 50 dB at 10 kHz
- AEC-Q100 qualified with the following results:
 - Device temperature Grade1:-40~125 $^{\circ}$ C ambient operating temperature range;
 - Device HBM ESD classification Level H2;
 - Device CDM ESD classification Level C3B.

Package

- 5-pin SOT23-5

Typical Application Circuit

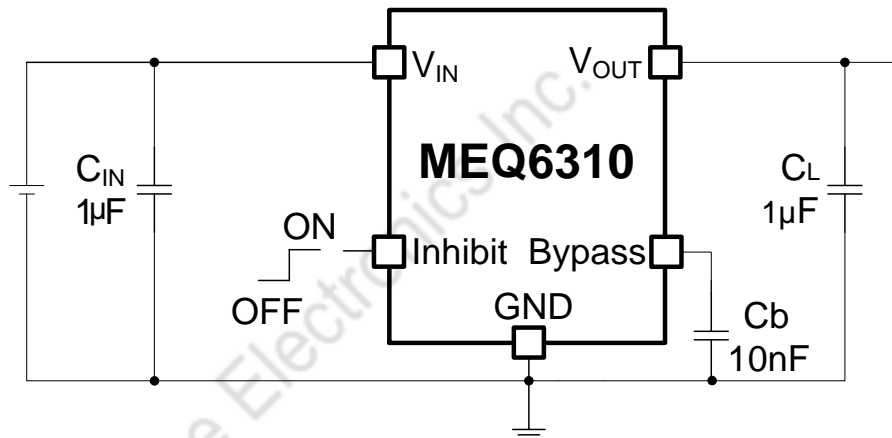

Selection Guide

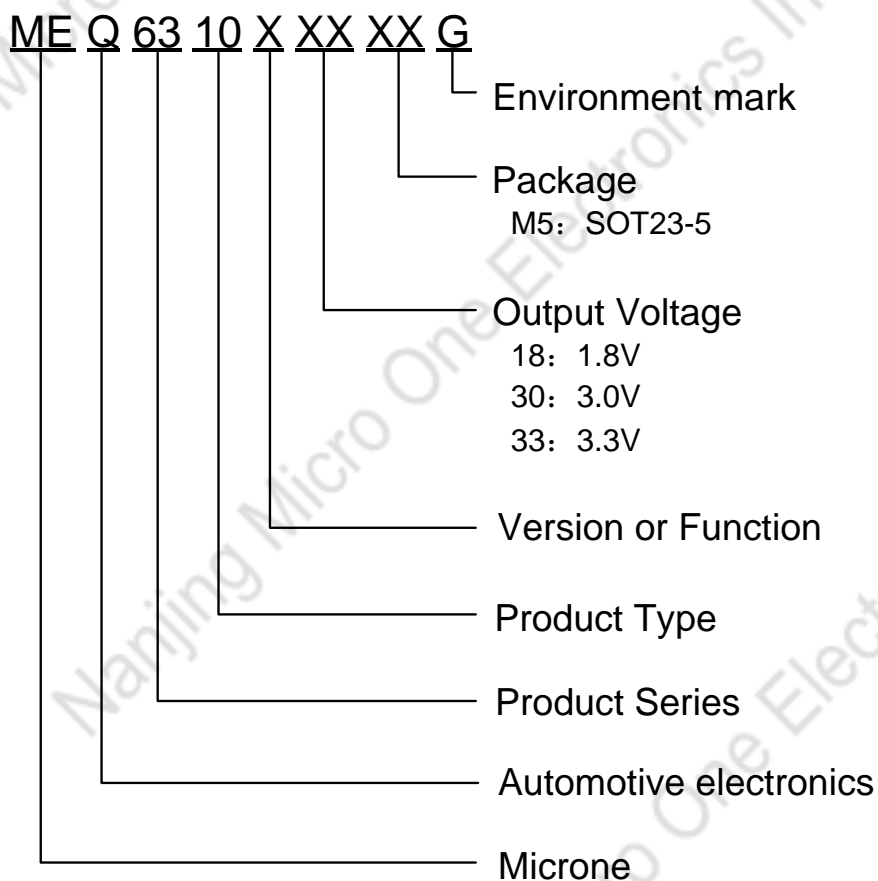

product series	product description
MEQ6310C18M5G	V _{OUT} =1.8V; Package: SOT23-5
MEQ6310C30M5G	V _{OUT} =3.0V; Package: SOT23-5
MEQ6310C33M5G	V _{OUT} =3.3V; Package: SOT23-5

Pin Configuration

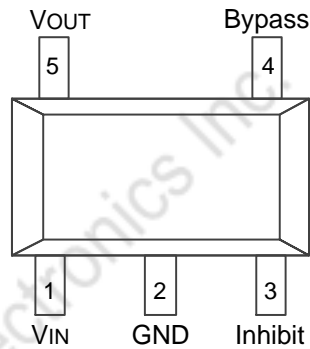

SOT23-5

Pin Assignment

PIN Number	symbol	Function
1	V_{IN}	Input voltage of the LDO
2	GND	Common Ground
3	Inhibit	Inhibit input voltage: ON mode when $V_{INH} \geq 1.2\text{ V}$, OFF mode when $V_{INH} \leq 0.4\text{ V}$ (Do not leave it floating, not internally pulled down/up)
4	Bypass	Bypass pin: an external capacitor (usually 10 nF) has to be connected to minimize noise voltage
5	V_{OUT}	Output voltage of the LDO

Block Diagram

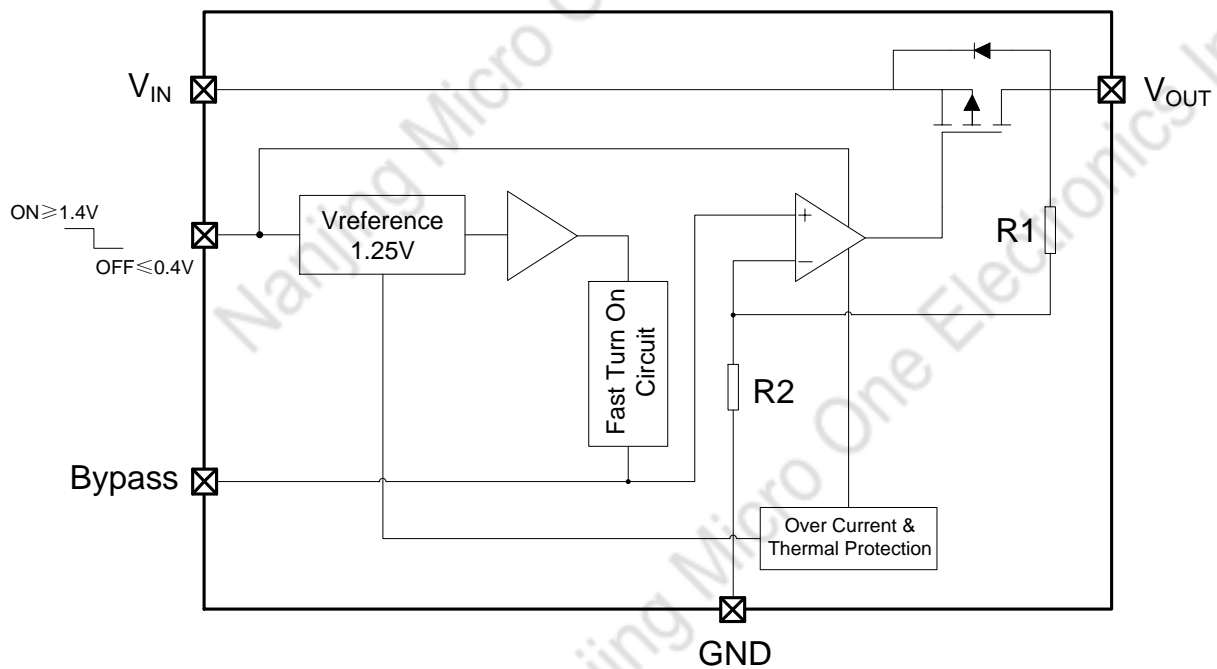

Absolute Maximum Ratings

Parameter	Symbol	Ratings	Units	
DC input voltage	V_{IN}	-0.3 ~ 6	V	
DC output voltage	V_O	-0.3 ~ $V_I+0.3$	V	
Inhibit input voltage	V_{INH}	-0.3 ~ $V_I+0.3$	V	
Output current	I_O	Internally limited		
Internal Power Dissipation (SOT23-5)	P_d	600	mW	
Thermal resistance (Junction to air) (SOT23-5)	θ_{JA}	210	°C/W	
Operating Ambient Temperature Range	T_A	-40~+125	°C	
Storage Temperature Range	T_{stg}	-55~+150	°C	
Junction temperature	T_J	-40~+150	°C	
Human-body model(HBM)	ESD(HBM)	±4000	V	
Charged-device model(CDM)	Corner Pins	ESD(CDM)	±750	V
	All Pins	ESD(CDM)	±500	V

Note: Use this IC within the stated maximum ratings. Operation beyond these limits may cause degrading or permanent damage to the device.

Electrical Characteristic

MEQ6310 test conditions: $T_A = 25\text{ }^\circ\text{C}$, $V_I = V_{O(NOM)} + 0.5\text{ V}$, $C_I = 1\text{ }\mu\text{F}$, $C_{BYP} = 10\text{ nF}$, $I_O = 1\text{ mA}$, $V_{INH} = 1.4\text{ V}$, unless otherwise specified.

Parameter	Symbol	Test conditions	Min	Typ	Max	Unit
Operating input voltage	V_I		2.6		6	V
Output voltage accuracy, $V_{O(NOM)} < 2.6\text{ V}$	V_O	$I_O = 1\text{ mA}$	-50		50	mV
		$T_A = -40\text{ to }125\text{ }^\circ\text{C}$	-75		75	
Output voltage accuracy, $V_{O(NOM)} \geq 2.6\text{ V}$	V_O	$I_O = 1\text{ mA}$	-2		2	% of $V_{O(NOM)}$
		$T_A = -40\text{ to }125\text{ }^\circ\text{C}$	-3		3	
Line regulation ⁽¹⁾	ΔV_O	$V_I = V_{O(NOM)} + 0.5\text{ to }6\text{ V}$ $T_A = -40\text{ to }125\text{ }^\circ\text{C}$	-0.1		0.1	%V
		$V_{O(NOM)} = 4.7\text{ to }5\text{ V}$	-0.19		0.19	
Load regulation	ΔV_O	$I_O = 1\text{ mA to }150\text{ mA}$, $V_{O(NOM)} < 2.6\text{ V}$, $T_A = -40\text{ to }125\text{ }^\circ\text{C}$		0.002	0.008	%/mA
Load regulation	ΔV_O	$I_O = 1\text{ mA to }150\text{ mA}$, $V_{O(NOM)} \geq 2.6\text{ V}$		0.0004	0.002	%/mA
		$I_O = 1\text{ mA to }150\text{ mA}$, $V_{O(NOM)} \geq 2.6\text{ V}$, $T_A = -40\text{ to }125\text{ }^\circ\text{C}$		0.0025	0.005	%/mA
Output AC line regulation ⁽²⁾	ΔV_O	$V_I = V_{O(NOM)} + 1\text{ V}$, $I_O = 150\text{ mA}$, $t_R = t_F = 30\text{ }\mu\text{s}$		1.5		mV _{PP}

Quiescent current ON mode: $V_{INH} = 1.2 V$	I_Q	$I_O = 0$		85		μA
		$I_O = 0, T_A = -40 \text{ to } 125 \text{ }^\circ C$			150	
$I_O = 0 \text{ to } 150 \text{ mA}$			170			
$I_O = 0 \text{ to } 150 \text{ mA}, T_A = -40 \text{ to } 125 \text{ }^\circ C$				250		
OFF mode: $V_{INH} = 0.4 V$				0.003		
		$T_A = -40 \text{ to } 125 \text{ }^\circ C$			1.5	
Dropout voltage ⁽³⁾	V_{DROP}	$I_O = 1 \text{ mA}$		0.4		mV
		$I_O = 1 \text{ mA}, T_A = -40 \text{ to } 125 \text{ }^\circ C$			2	
		$I_O = 50 \text{ mA}$		20		
		$I_O = 50 \text{ mA}, T_A = -40 \text{ to } 125 \text{ }^\circ C$			35	
		$I_O = 100 \text{ mA}$		45		
		$I_O = 100 \text{ mA}, T_A = -40 \text{ to } 125 \text{ }^\circ C$			70	
		$I_O = 150 \text{ mA}$		60		
		$I_O = 150 \text{ mA}, T_A = -40 \text{ to } 125 \text{ }^\circ C$			100	
Short-circuit current	I_{SC}	$R_L = 0$		450		mA
Supply voltage rejection	PSRR	$V_I = V_{O(NOM)} + 0.25 V$ $\pm V_{RIPPLE} = 0.1 V,$ $I_O = 50 \text{ mA } V_{O(NOM)} < 2.6 V, V_I = 2.65 V$	$f = 1 \text{ kHz}$	60		dB
			$f = 10 \text{ kHz}$	50		
Peak output current	$I_{O(PK)}$	$V_O \geq V_{O(NOM)} - 5\%$	300	450		mA
Inhibit input logic low	V_{INH}	$V_I = 2.6 V \text{ to } 6 V,$ $T_A = -40 \text{ to } 125 \text{ }^\circ C$			0.4	V
Inhibit input logic high			1.2			
Inhibit input current	I_{INH}	$V_{INH} = 0.4 V, V_I = 6 V$		± 1		nA
Output noise voltage	eN	$B_W = 10 \text{ Hz to } 100 \text{ kHz},$ $C_O = 1 \mu F$		30		μV_{RMS}
Turn-on time ⁽⁴⁾	t_{ON}	$C_{BYP} = 10 \text{ nF}$		100	250	μs
Thermal shutdown	T_{SHDN}	⁽⁵⁾		160		$^\circ C$
Output capacitor	C_O	Capacitance ⁽⁶⁾	1		22	μF
		ESR	5		5000	$m\Omega$

1. For $V_{O(NOM)} < 2 V, V_I = 2.6 V$

2. For $V_{O(NOM)} = 1.25 V, V_I = 2.6 V$

3. Dropout voltage is the input-to-output voltage difference at which the output voltage is 100 mV below its nominal value. This specification does not apply to input voltages below 2.6 V

4. Turn-on time is time measured between the enable input just exceeding V_{INH} high value and the output voltage just reaching 95% of its nominal value

5. Typical thermal protection hysteresis is 30 $^\circ C$

6. The minimum capacitor value is 1 μF , anyway the MEQ6310 is still stable if the compensation capacitor has a 30% tolerance in all temperature range.

Typical Performance Characteristics

$T_A = 25^\circ\text{C}$, $V_I = V_{O(NOM)} + 0.5\text{V}$, when $V_{O(NOM)} < 2.1\text{V}$, $V_I = 2.6\text{V}$, $C_I = C_O = 1\mu\text{F}$, $C_{BYP} = 10\text{nF}$, $I_O = 1\text{mA}$, $V_{INH} = 1.4\text{V}$, unless otherwise noted.

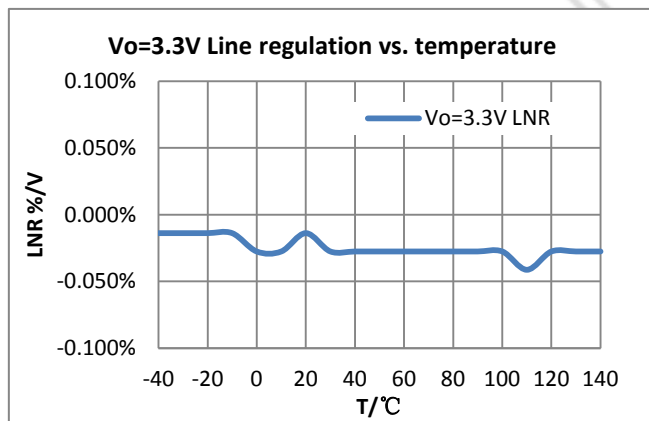
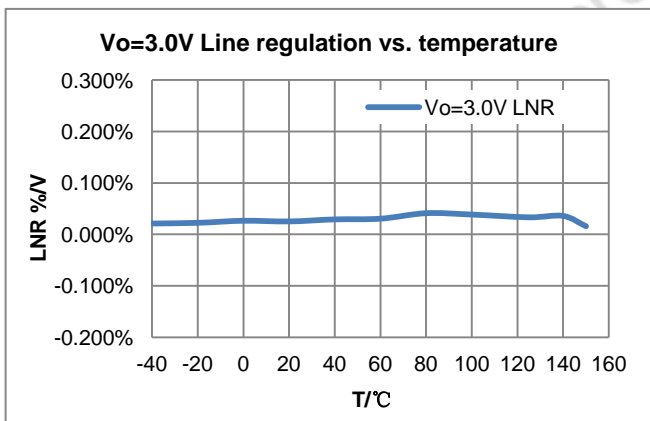
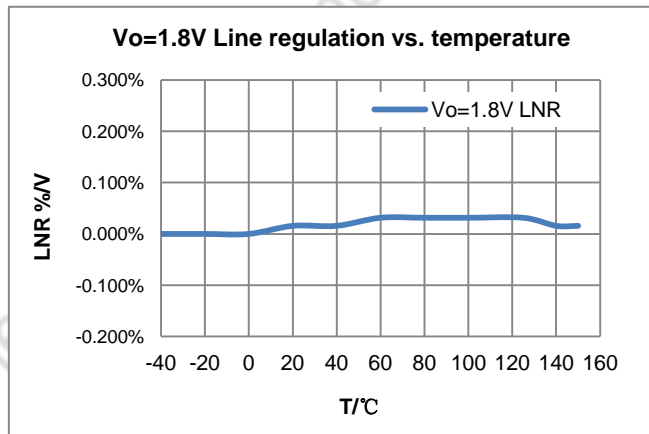
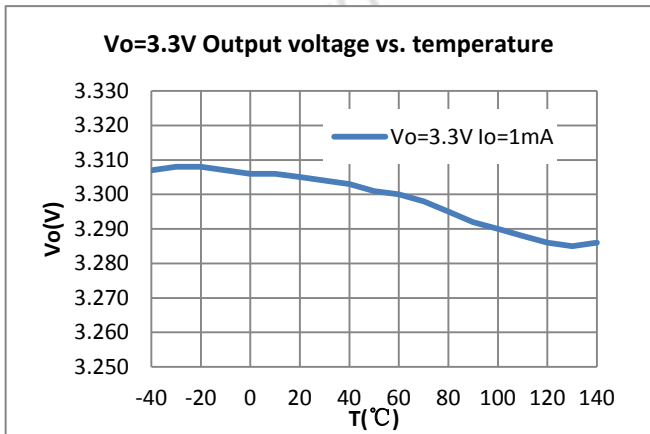
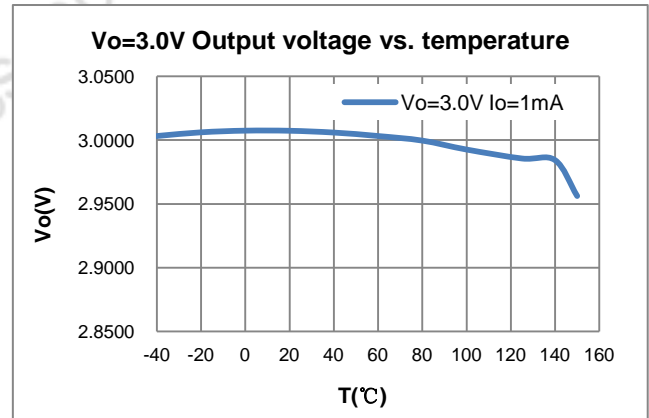
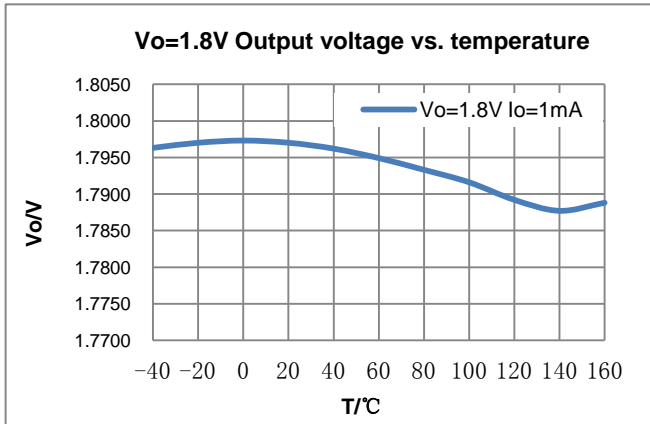

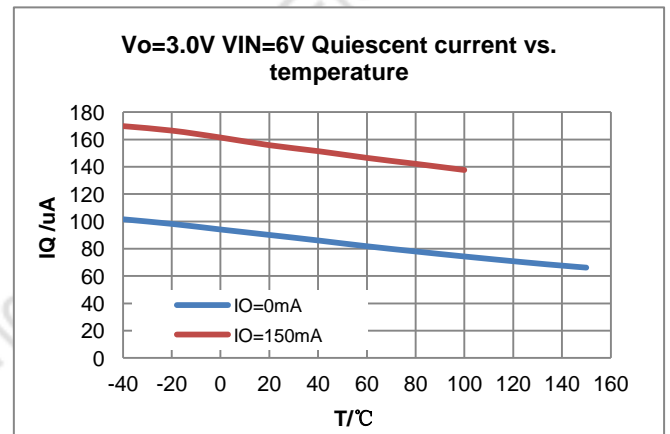
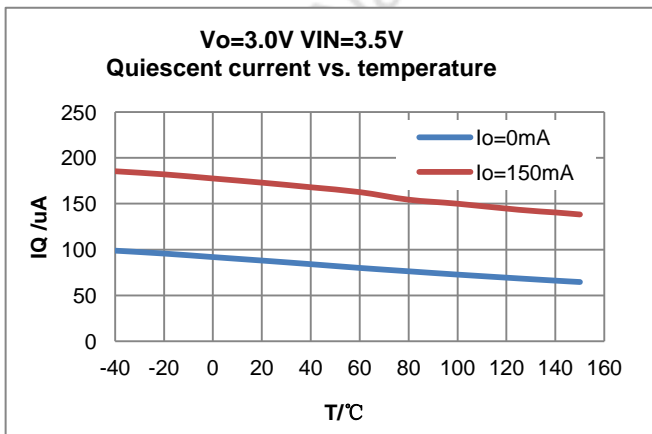
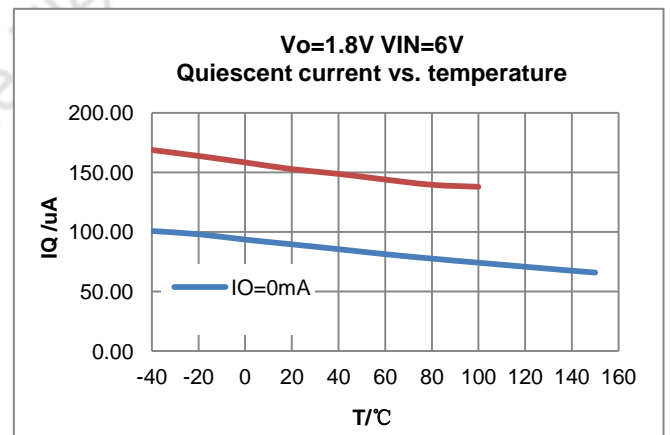
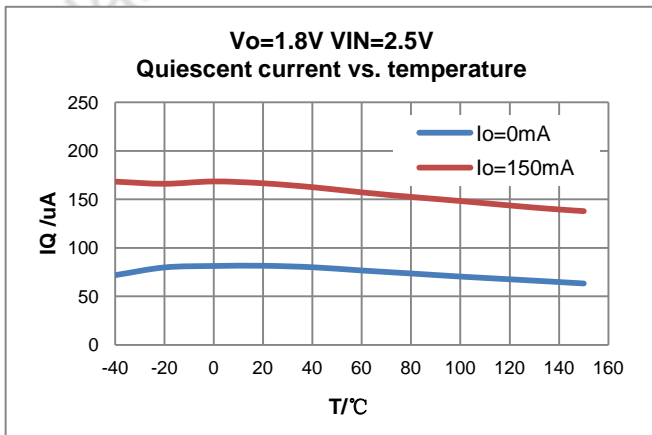
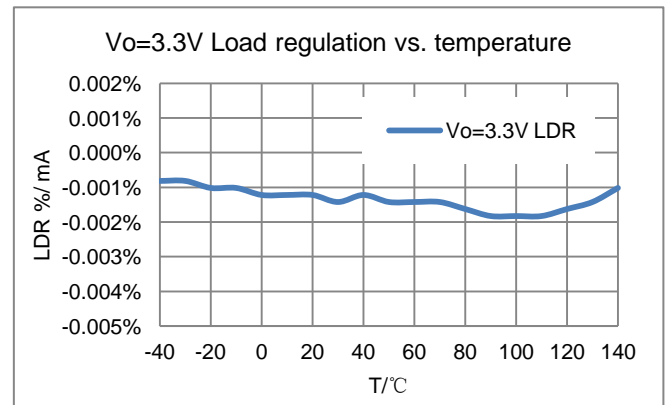
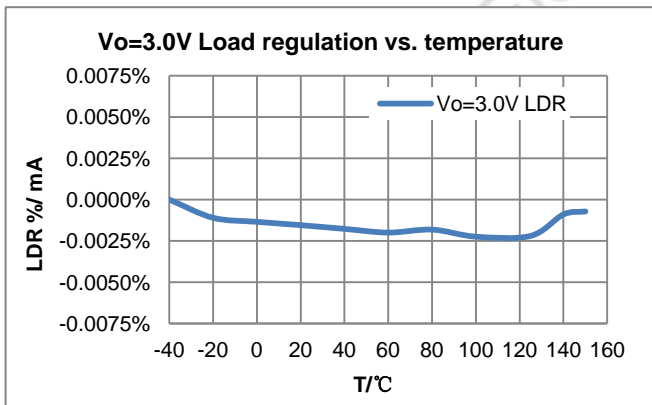
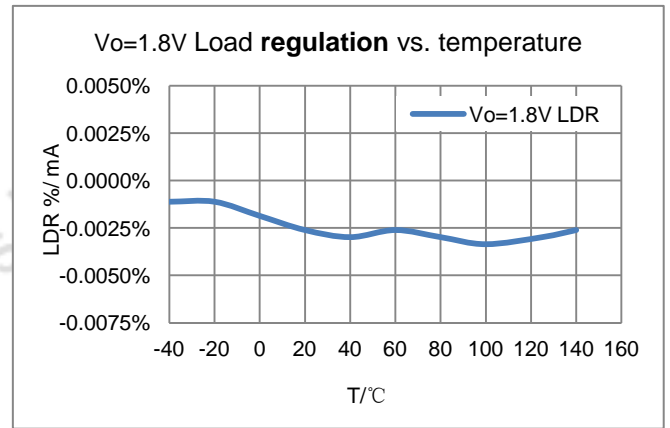
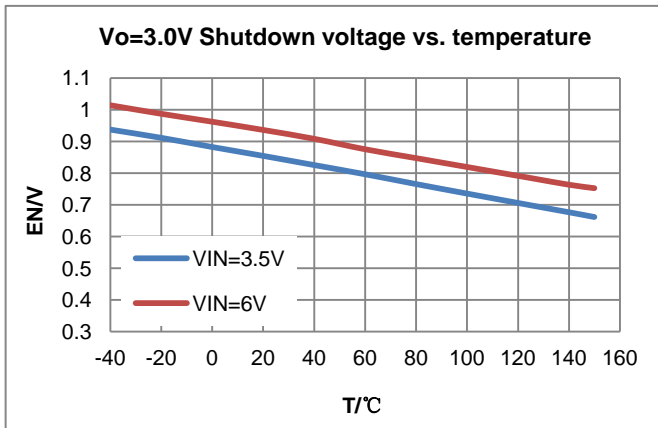

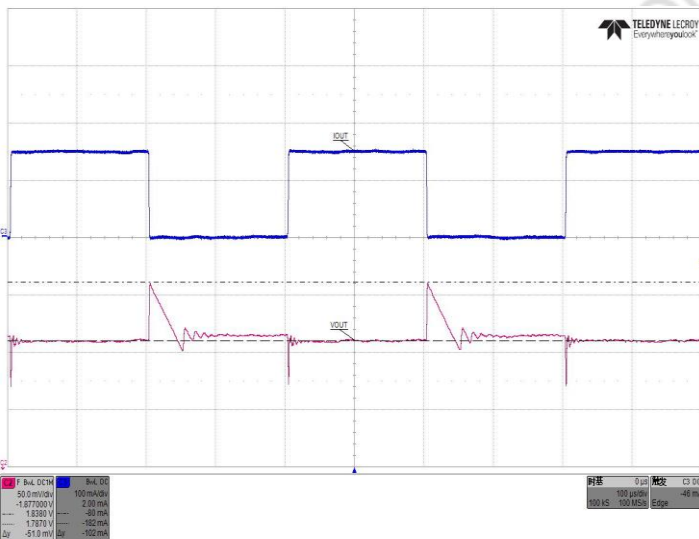
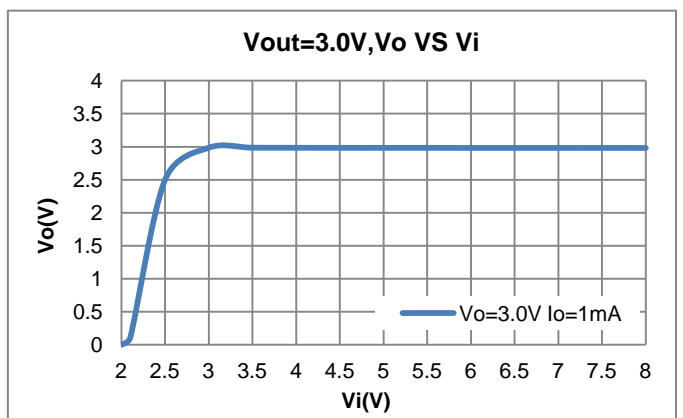
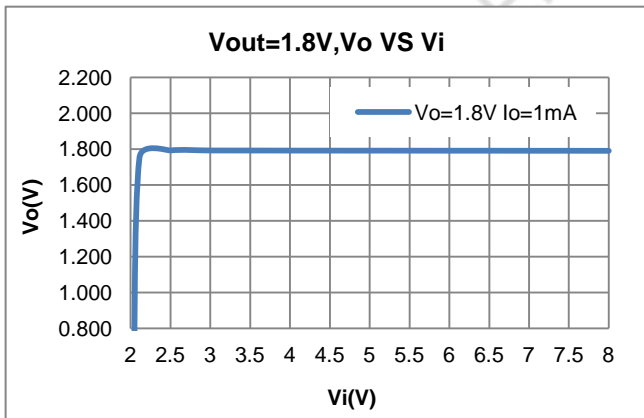
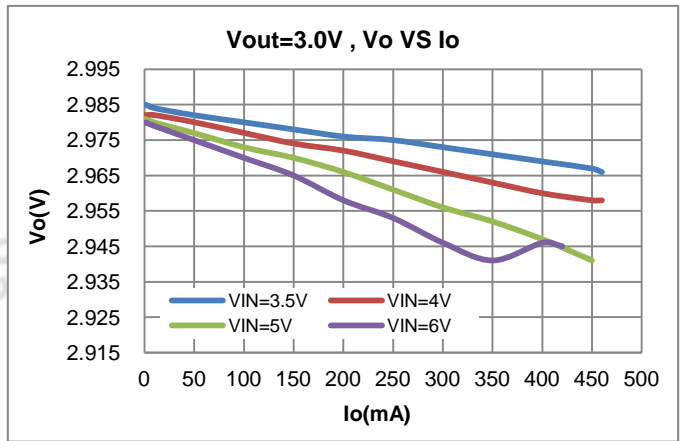
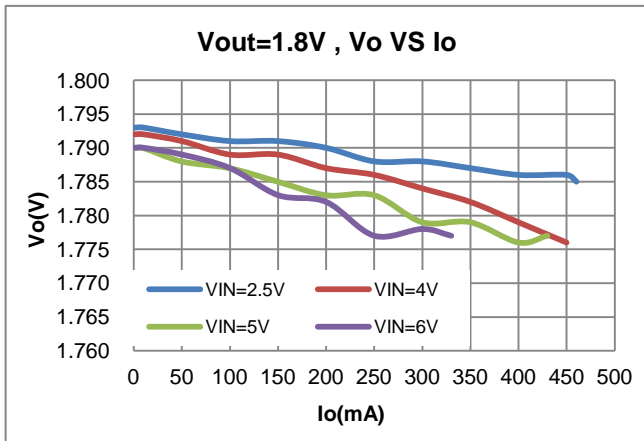

VO=1.8V,load 1-150mA dynamic rise-fall time =1us

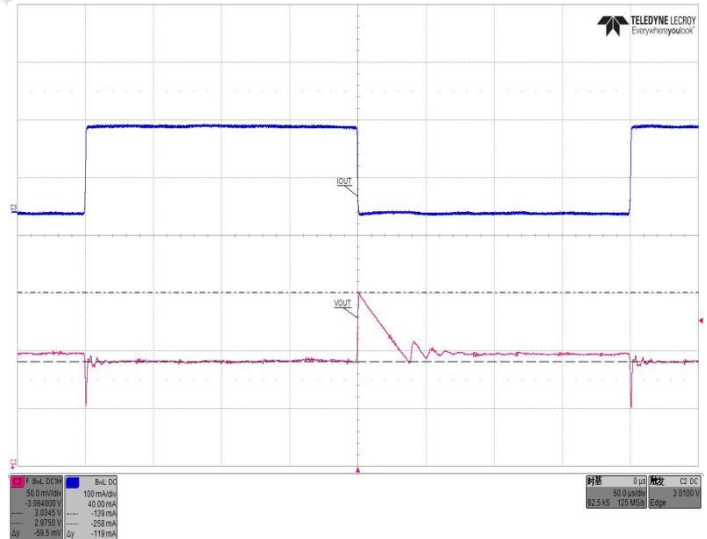

VO=3.0V,load1-150mA dynamic rise-fall time =1us

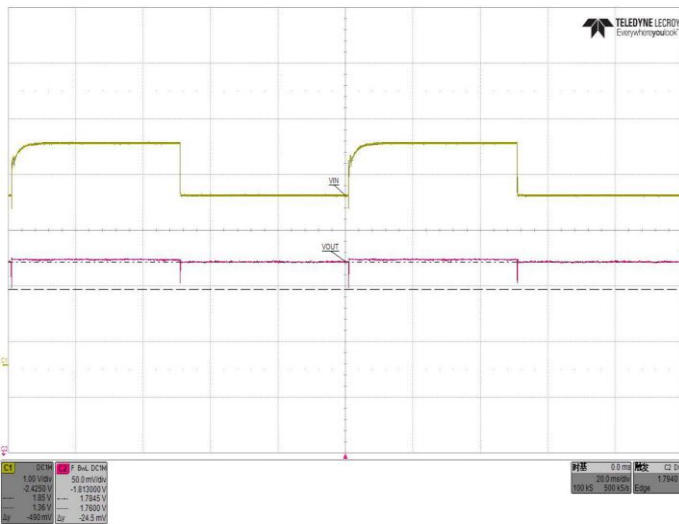

Power response, VIN=3-4V, IO=150mA

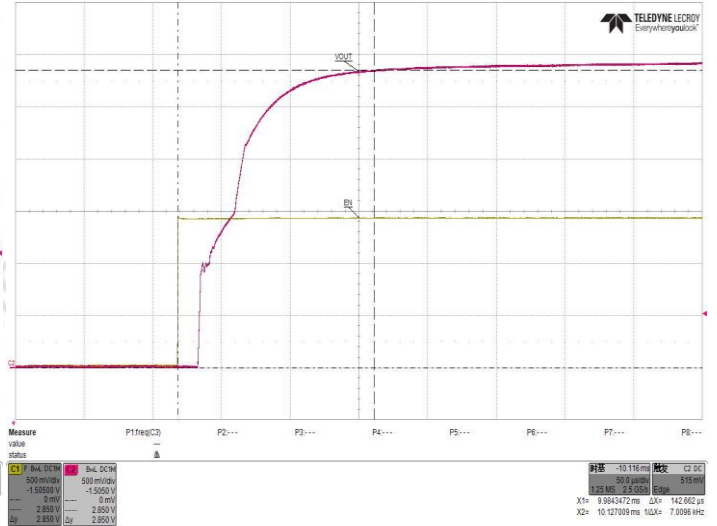

VO=3.0V, Tr=20nS, Start-up

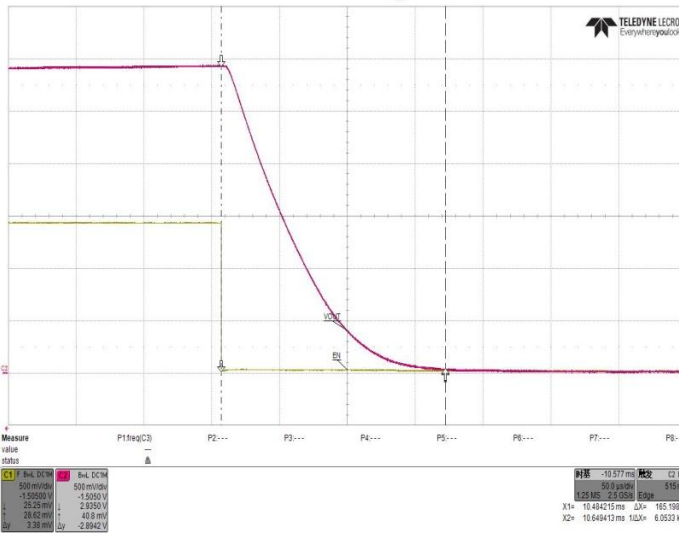

VO=3.0V, Tf=20nS, Turn-off

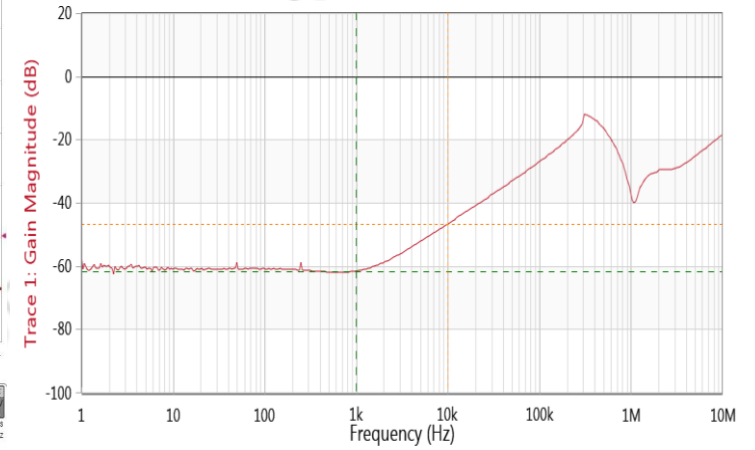

VO=1.8V, IO=50mA, PSRR

Package Quantity

Package Type	Minimum Packing QTY	UNITS	Small Box	Large BOX
SOT23-5	3000	Tape & Reel	30K	120K

Packaging Information

- Packaging Type: SOT23-5

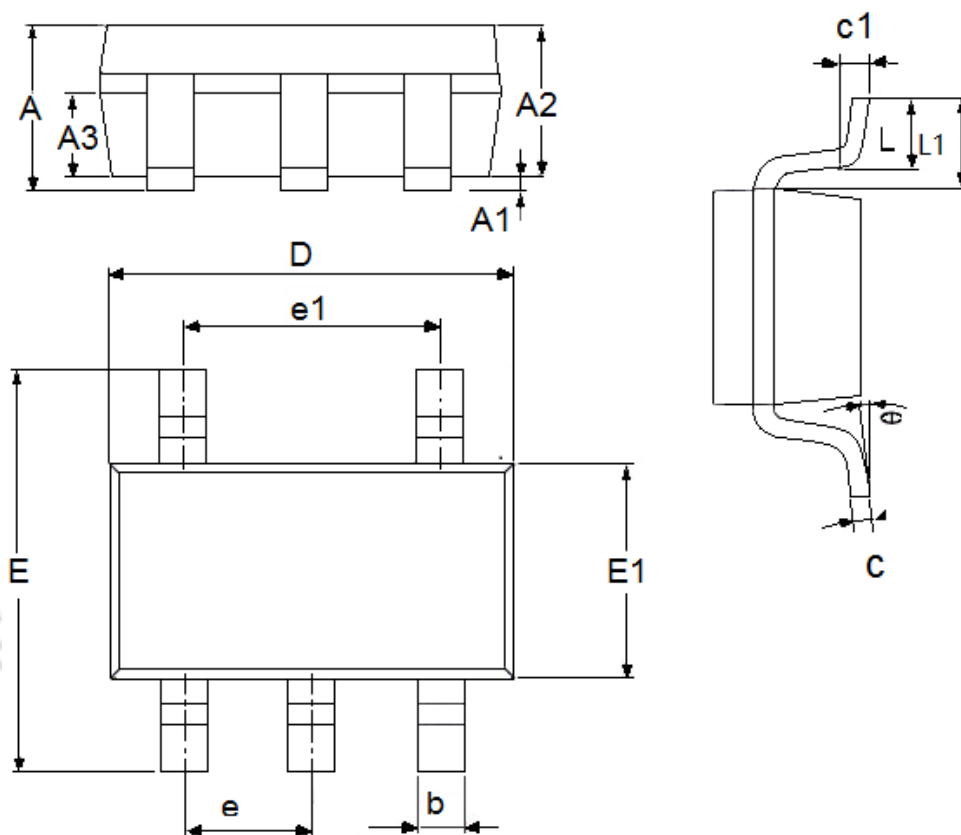

DIM	Millimeters		Inches	
	Min	Max	Min	Max
A	1.05	1.45	0.0413	0.0571
A1	0	0.15	0.0000	0.0059
A2	0.9	1.3	0.0354	0.0512
A3	0.6	0.7	0.0236	0.0276
b	0.25	0.5	0.0098	0.0197
c	0.1	0.23	0.0039	0.0091
D	2.82	3.05	0.1110	0.1201
e1	1.9(TYP)		0.0748(TYP)	
E	2.6	3.05	0.1024	0.1201
E1	1.5	1.75	0.0512	0.0689
e	0.95(TYP)		0.0374(TYP)	
L	0.3	0.6	0.0118	0.0236
L1	0.59(TYP)		0.0232(TYP)	
θ	0	8°	0.0000	8°
c1	0.2(TYP)		0.0079(TYP)	

- The contents of this document will be updated with the product's improvement without prior notice. Please consult our sales staff before using this document to ensure that you are using the latest version.
- The application circuit examples described in this document are only used to indicate the representative use of the product and do not guarantee the design of mass production.
- Please use this product within the limits stated in this document. We will not be responsible for any damage caused by improper use.
- The products described in this document are not allowed to be used in equipment or devices that affect the human body without the written permission of our company, including but not limited to: health equipment, medical equipment, disaster prevention equipment, fuel control equipment, automobile equipment, aviation equipment and vehicle equipment.
- Although our company has always been committed to improving product quality and reliability, semiconductor products have a certain probability of malfunction or wrong work. To prevent personal injury or property damage caused by such accidents, please pay full attention to safety design, for example: Alternate design, fire protection design, and prevention of wrong action design.
- When exporting this product or this document overseas, you should abide by applicable import and export control laws.
- Copying or reprinting part or all of this document in any form without the permission of our company is strictly prohibited.